

Strukturkennzeichenübersicht

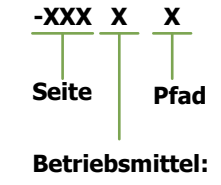
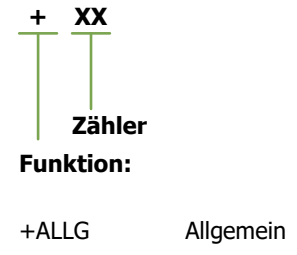
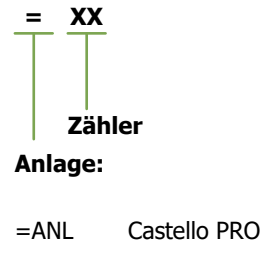

&EAB/2				&EFS++AL+ALLG/20				
V1.0	19.02.2021	sstern	Datum	14.01.2021	Schirmsteuerung 350 01 5620XX	Strukturkennzeichnungsübersicht		= ANL
			Bearb.	sstern				+
Änderung	Datum	Name			Ersatz von	Ersetzt durch	Zeichnungsnummer 350 01 5620XX	Blatt 10 Seite 3 / 8

++ST
Steuerung

-30T1
/30.1
BN
BU
GNYE
L3 / 30.1
N3 / 30.1
PE3 / 30.1

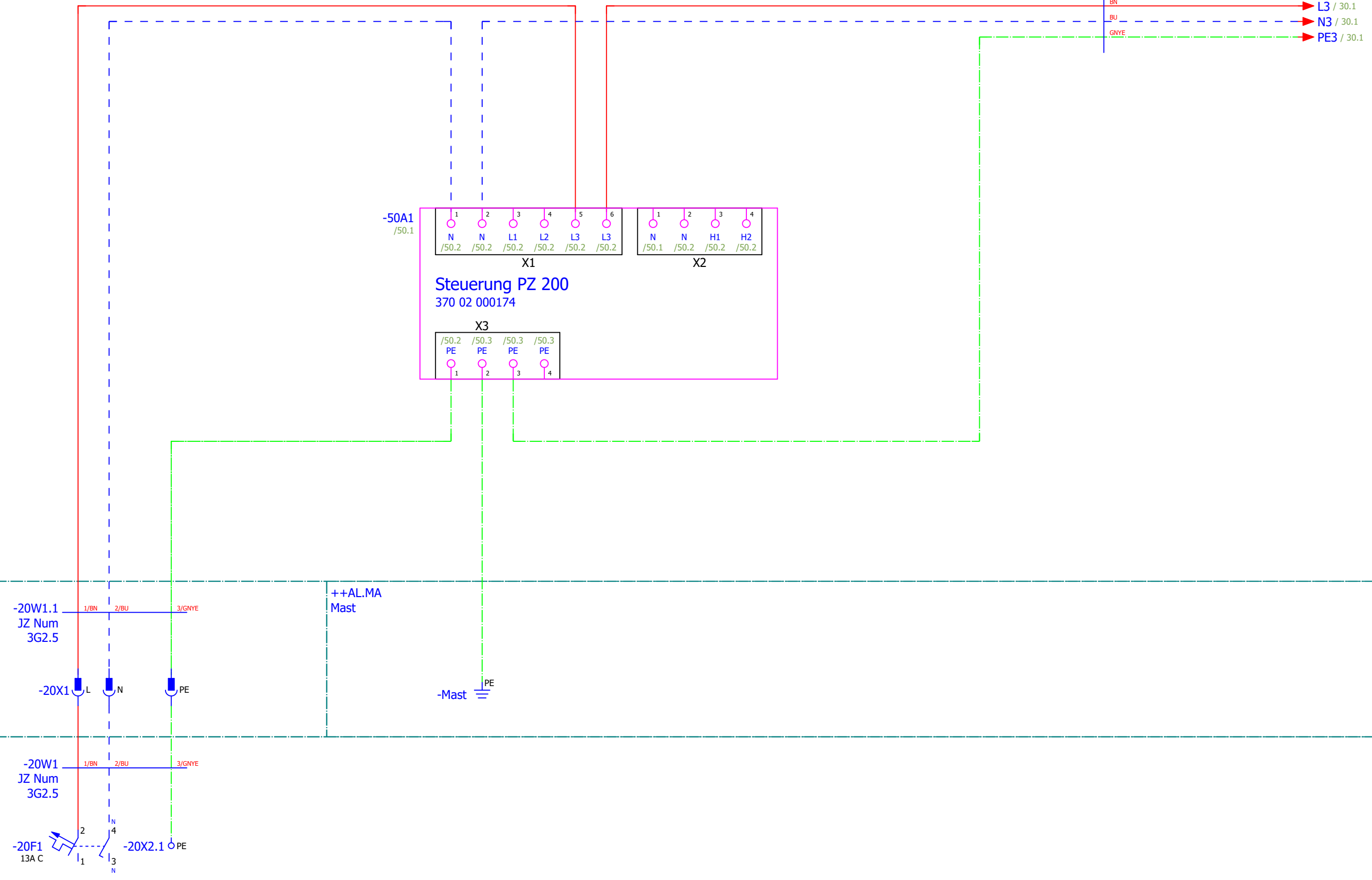

Einspeisung:
 Nennspannung 230V AC
 Vorsicherung max. 13A
 Nullungsart TN-S
 Leitungsart L N PE
 Frequenz 50Hz

V1.0	19.02.2021	sstern	Datum	14.01.2021	Schirmsteuerung	Einspeisung	= ANL + ALLG
			Bearb.	sstern	350 01 5620XX		
Änderung	Datum	Name			Ersatz von	Ersetzt durch	Zeichnungsnummer 350 01 5620XX
							Blatt 20 Seite 4 / 8

++ST
Steuerung

-50A1
/50.1

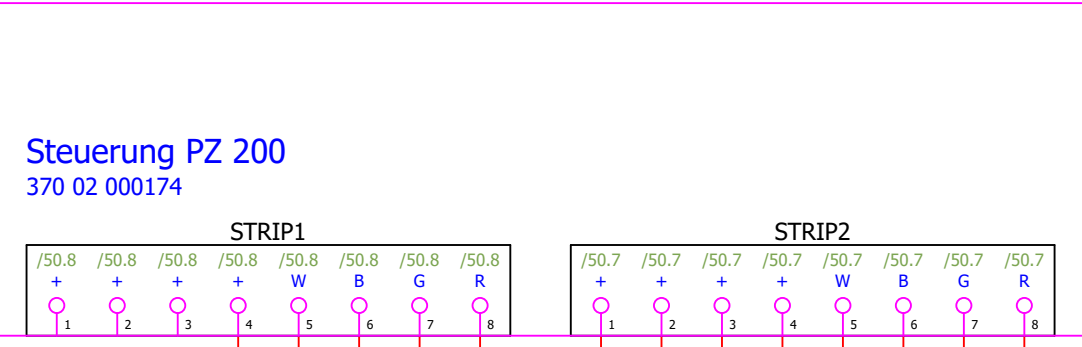

36.1 / STRIP1_+
36.1 / STRIP1_W
36.1 / STRIP1_B
36.1 / STRIP1_G
36.1 / STRIP1_R

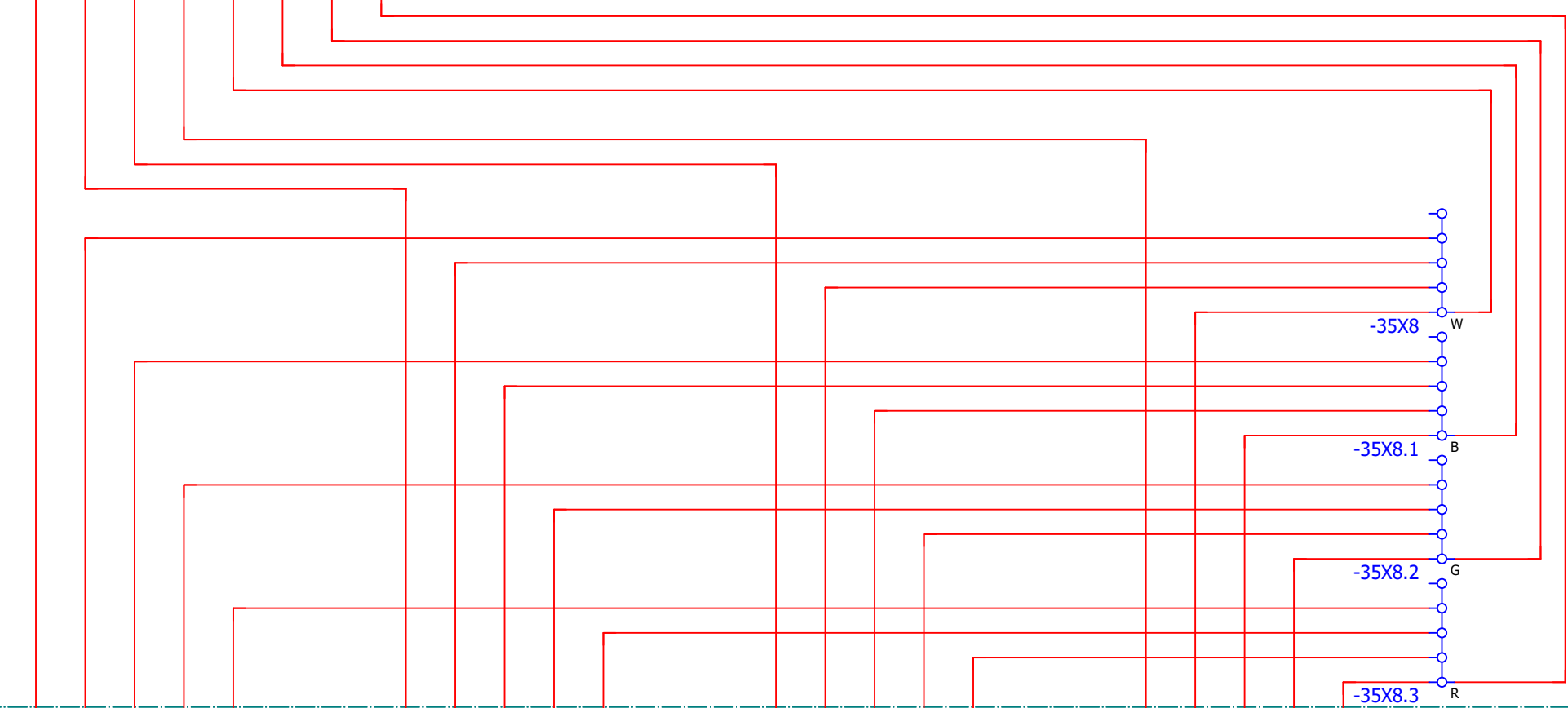

++AL.SH
Schirm

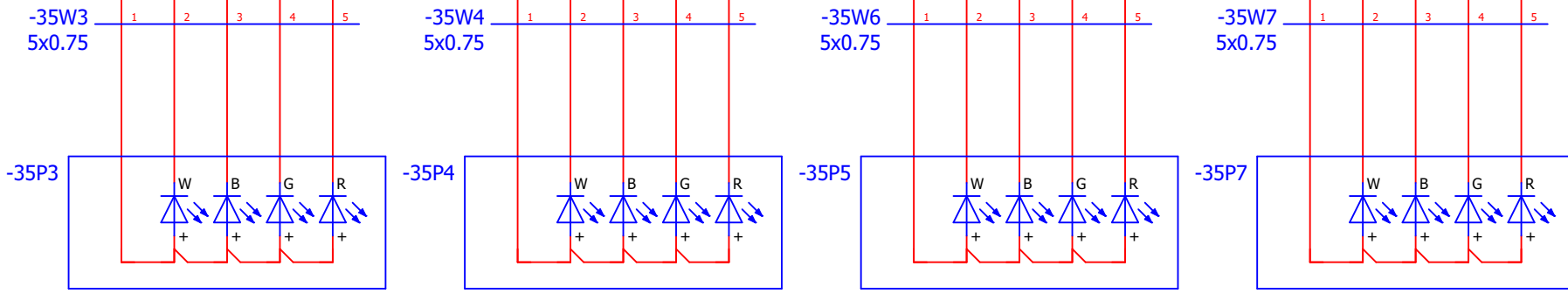

LED 1

LED 2

LED 3

LED 4

V1.0	19.02.2021	sstern	Datum	14.01.2021	Schirmsteuerung	= ANL
			Bearb.	sstern	350 01 5620XX	+ ALLG
Änderung	Datum	Name			Ersatz von	Ersetzt durch
Zeichnungsnummer						Blatt
350 01 5620XX						35
						Seite
						6 / 8

++ST
Steuerung

35.2 / STRIP1_R
35.2 / STRIP1_G
35.2 / STRIP1_B
35.2 / STRIP1_W
35.2 / STRIP1_+

-36W1.1
5x0.75

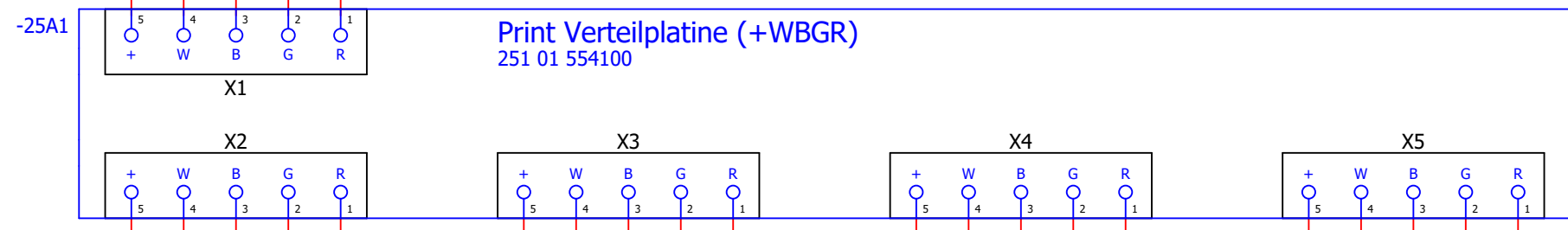

++AL.SH
Schirm

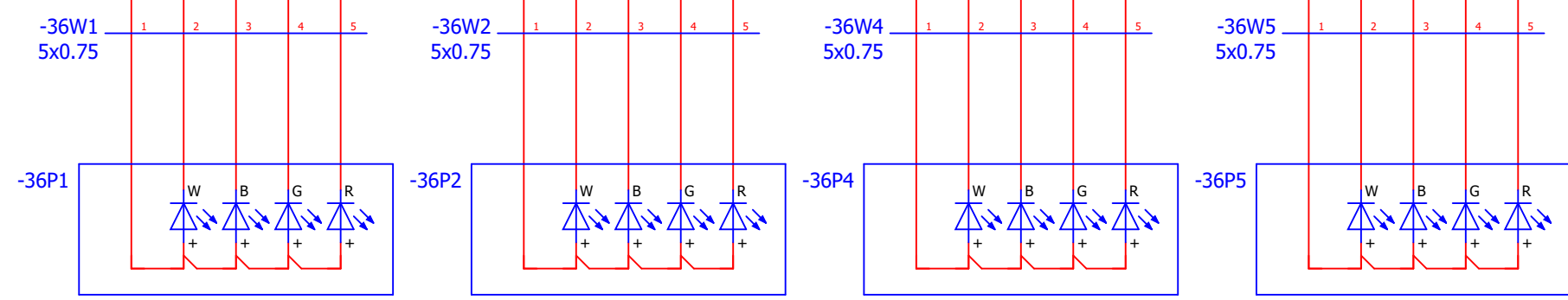

LED 5

LED 6

LED 7

LED 8

V1.0	19.02.2021	sstern	Datum	14.01.2021	Schirmsteuerung			= ANL
			Bearb.	sstern	350 01 5620XX			+ ALLG
Änderung	Datum	Name			Ersatz von	Ersetzt durch		
							Steuerung Licht	
							Zeichnungsnummer	Blatt
							350 01 5620XX	36
								Seite
								7 / 8



Glatz AG

Neuhofstrasse 12

CH-8500 Frauenfeld

Phone 0041 52 723 64 64

Fax 0041 52 723 66 39

www.glatz.ch

Project description

Sunshade control
350 01 5620XX

Type	LED
Year of constuction	2021
Protection class	-
Pre-fuse	13A
Frequency	50Hz
Supply line	L N PE
Control voltage	230V AC
short-circuit proof Icp	10kA
Ambient temperature	max. 20°C when heating, otherwise up to 40°C at the most

Edit date 19.02.2021

Number of pages 8

V1.0	19.02.2021	sstern	Date	19.02.2021	Sunshade control	Cover sheet	= ANL			
			Ed.	sstern	350 01 5620XX		+			
Modification	Date	Name			Replacement of	Replaced by				
								Drawing number		Page 1
								350 01 5620XX		Page 1 / 8

Table of contents

& Document	=Machine	++Installation site	+Function	Page	Page description	Date	Edited by
EAA	=ANL			1	Cover sheet	19.02.2021	ssstern
EAB	=ANL			2	Table of contents	19.02.2021	ssstern
EAC	=ANL			10	Overview structure identification	19.02.2021	ssstern
EFS	=ANL	++AL	+ALLG	20	Infeed	19.02.2021	ssstern
EFS	=ANL	++AL	+ALLG	30	Power supply unit/ Reed switch	19.02.2021	ssstern
EFS	=ANL	++AL	+ALLG	35	Light control	19.02.2021	ssstern
EFS	=ANL	++AL	+ALLG	36	Light control	19.02.2021	ssstern
EFS	=ANL	++AL	+ALLG	50	Control PZ 200	19.02.2021	ssstern

Structure identifier overview

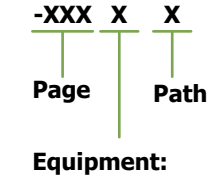
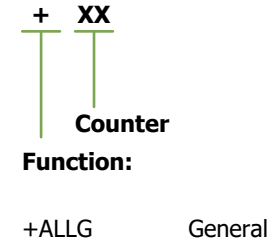
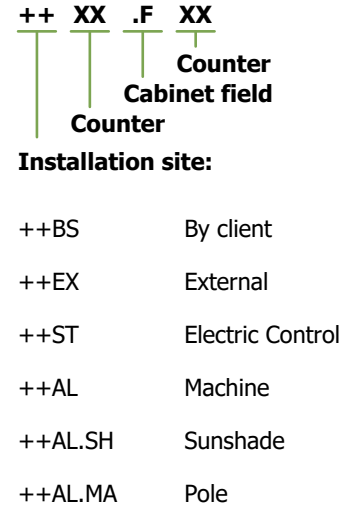
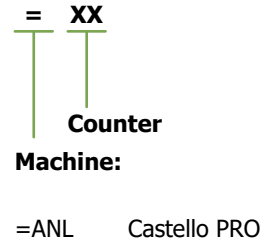
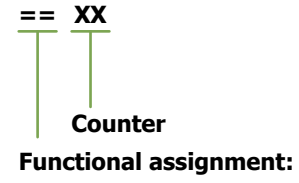

V1.0	19.02.2021	sstern	Date	19.02.2021	Sunshade control	Overview structure identification	= ANL +	Drawing number 350 01 5620XX	Page 10
			Ed.	sstern	350 01 5620XX				
Modification	Date	Name			Replacement of	Replaced by			Page 3 / 8

++ST
Electric Control

-30T1
/30.1
BN
BU
GNYE
L3 / 30.1
N3 / 30.1
PE3 / 30.1

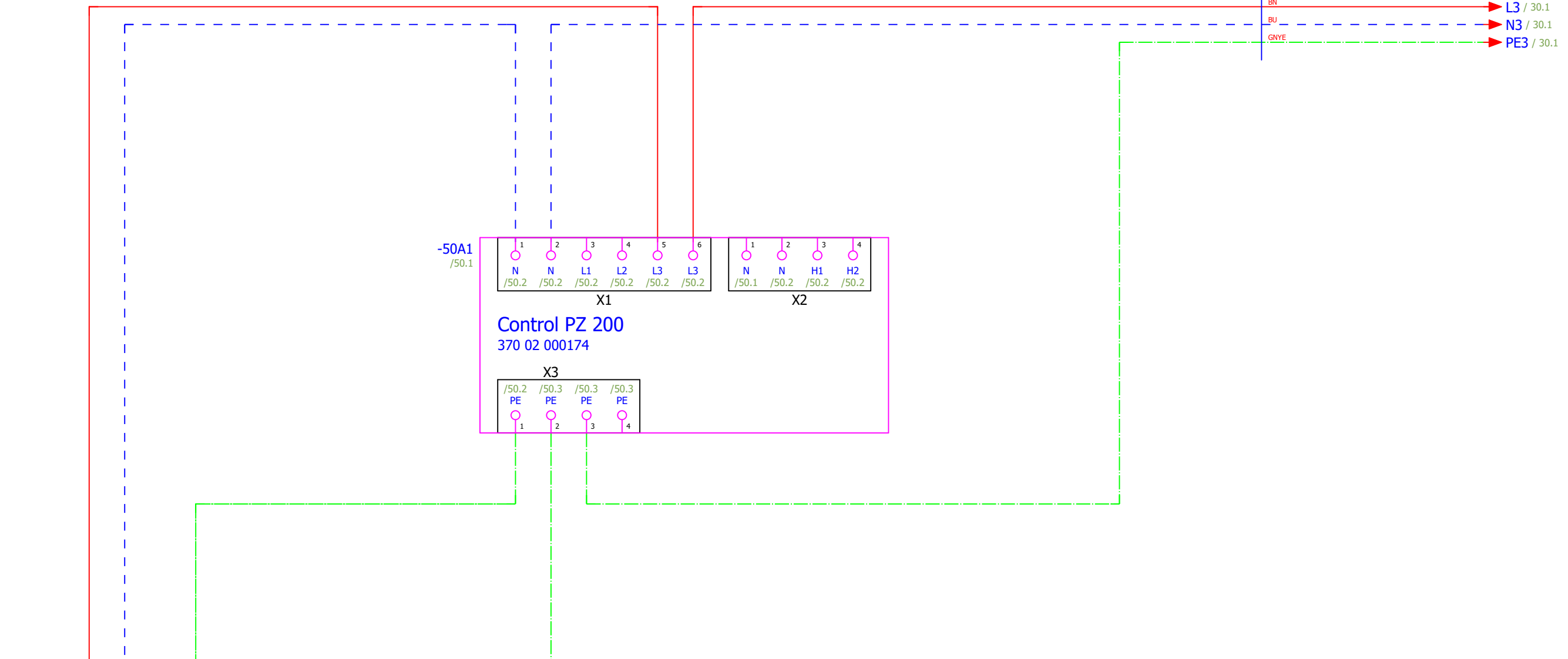

++EX
External

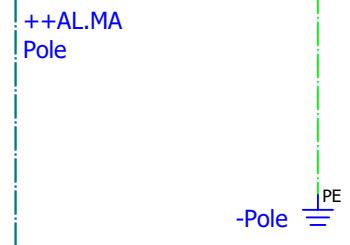
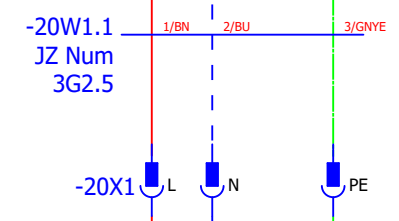

++BS
By client

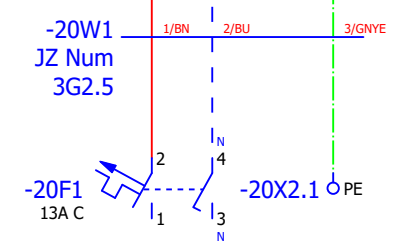

Infeed	
Nominal voltage	230V AC
Max. back-up fuse	13A
Electrical system	TN-S
Type of connection	L N PE
Frequency	50Hz

V1.0	19.02.2021	sstern	Date	19.02.2021	Sunshade control	Infeed	= ANL + ALLG	
			Ed.	sstern	350 01 5620XX			
Modification	Date	Name			Replacement of	Replaced by	Drawing number 350 01 5620XX	
							Page	20
							Page	4 / 8

++ST
Electric Control

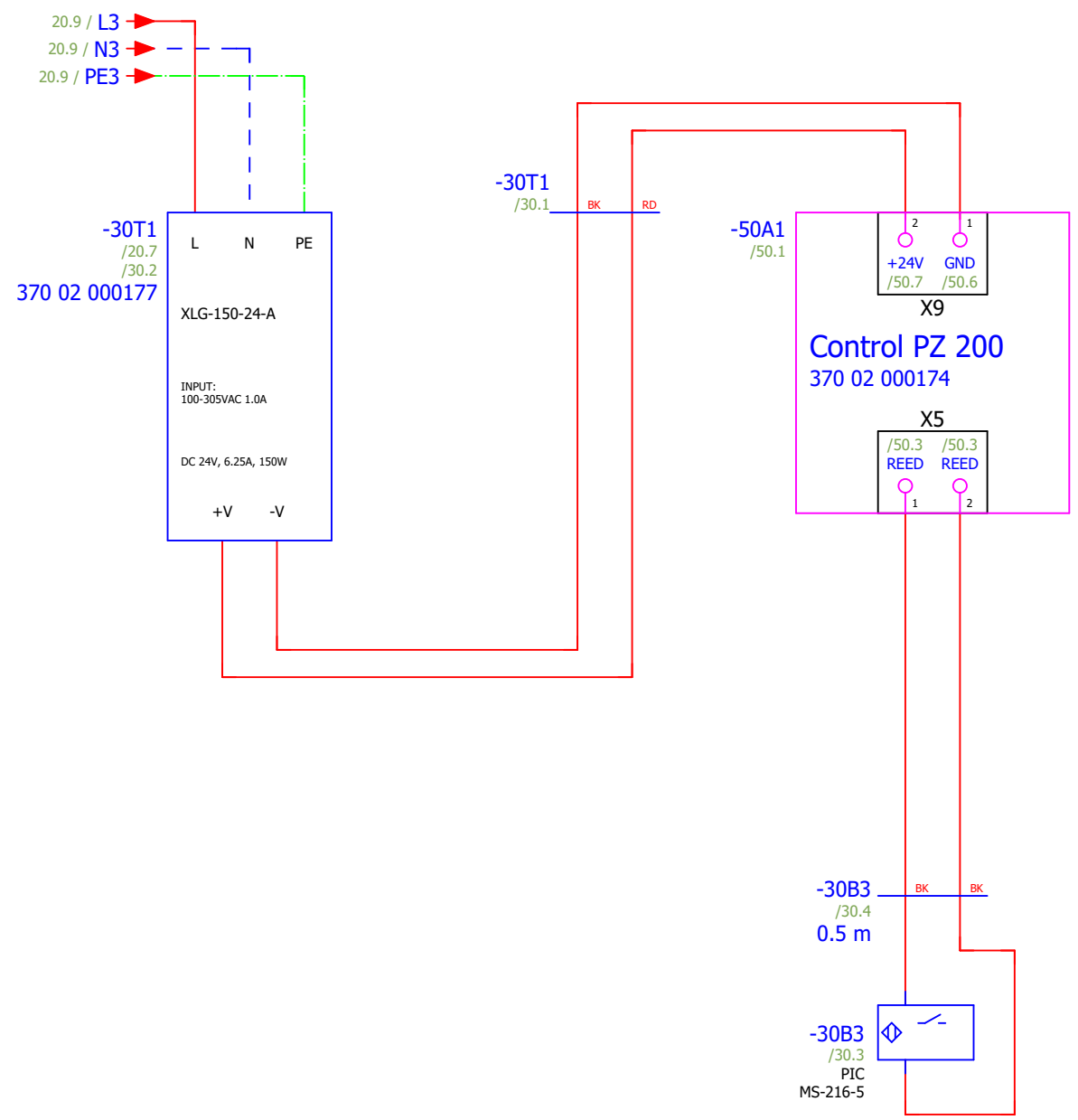

Reed switch

20					35		
V1.0	19.02.2021	sstern	Date	19.02.2021	Sunshade control 350 01 5620XX	Power supply unit/ Reed switch	= ANL
			Ed.	sstern			+ ALLG
Modification	Date	Name			Replacement of	Replaced by	
							Drawing number 350 01 5620XX
							Page 30 Page 5 / 8

++ST
Electric Control

-50A1
/50.1

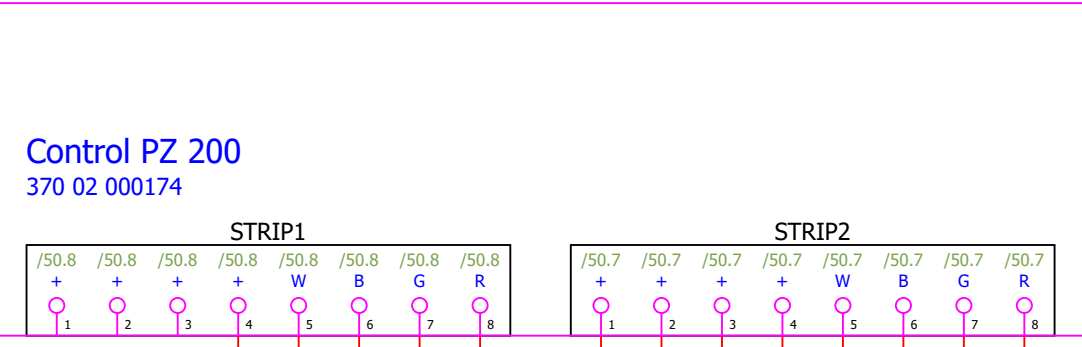

36.1 / STRIP1_+
36.1 / STRIP1_W
36.1 / STRIP1_B
36.1 / STRIP1_G
36.1 / STRIP1_R

-35X8 W
-35X8.1 B
-35X8.2 G
-35X8.3 R

++AL.SH
Sunshade

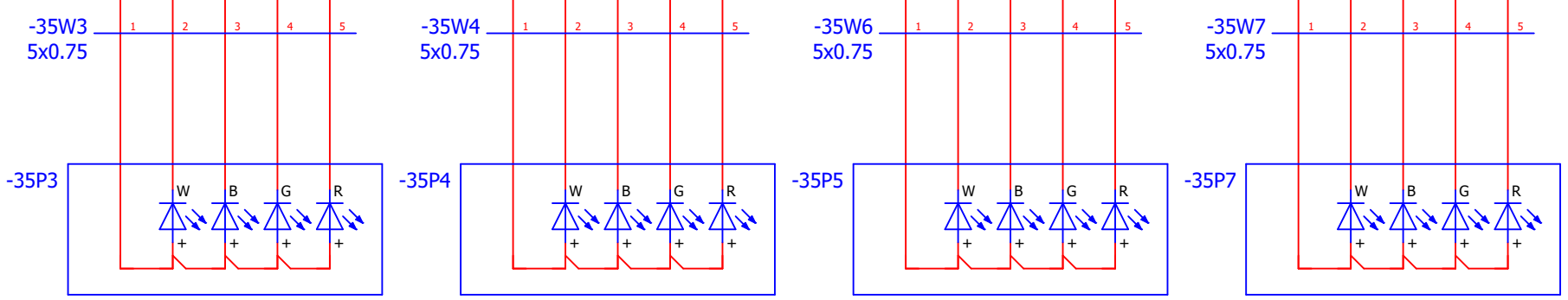

LED 1

LED 2

LED 3

LED 4

V1.0	19.02.2021	sstern	Date	19.02.2021	Sunshade control		= ANL	
			Ed.	sstern	350 01 5620XX		+ ALLG	
Modification	Date	Name			Replacement of	Replaced by		
							Drawing number	Page
							350 01 5620XX	35
								Page 6 / 8

++ST
Electric Control

35.2 / STRIP1_R
35.2 / STRIP1_G
35.2 / STRIP1_B
35.2 / STRIP1_W
35.2 / STRIP1_+

-36W1.1
5x0.75

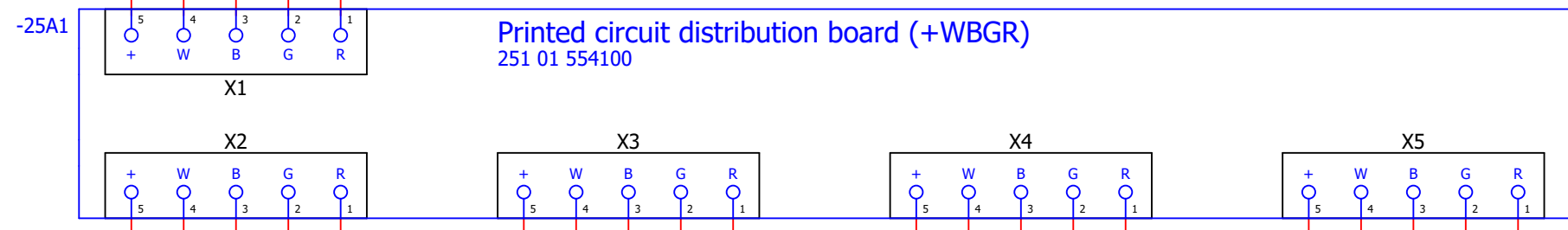

++AL.SH
Sunshade

-36W1
5x0.75

-36W2
5x0.75

-36W4
5x0.75

-36W5
5x0.75

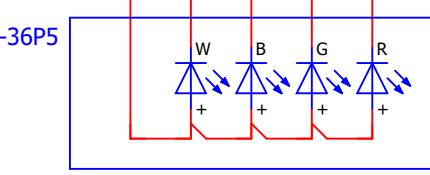
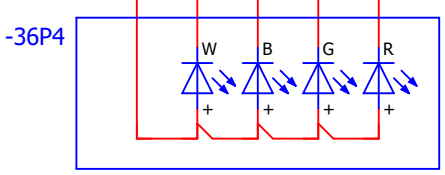
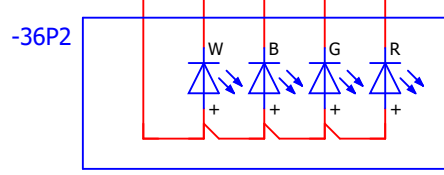
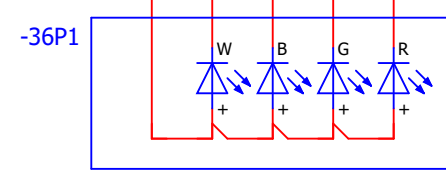

LED 5

LED 6

LED 7

LED 8

V1.0	19.02.2021	sstern	Date	19.02.2021	Sunshade control	Light control	= ANL
			Ed.	sstern	350 01 5620XX		+ ALLG
Modification	Date	Name			Replacement of	Replaced by	Drawing number
							350 01 5620XX
							Page
							7 / 8

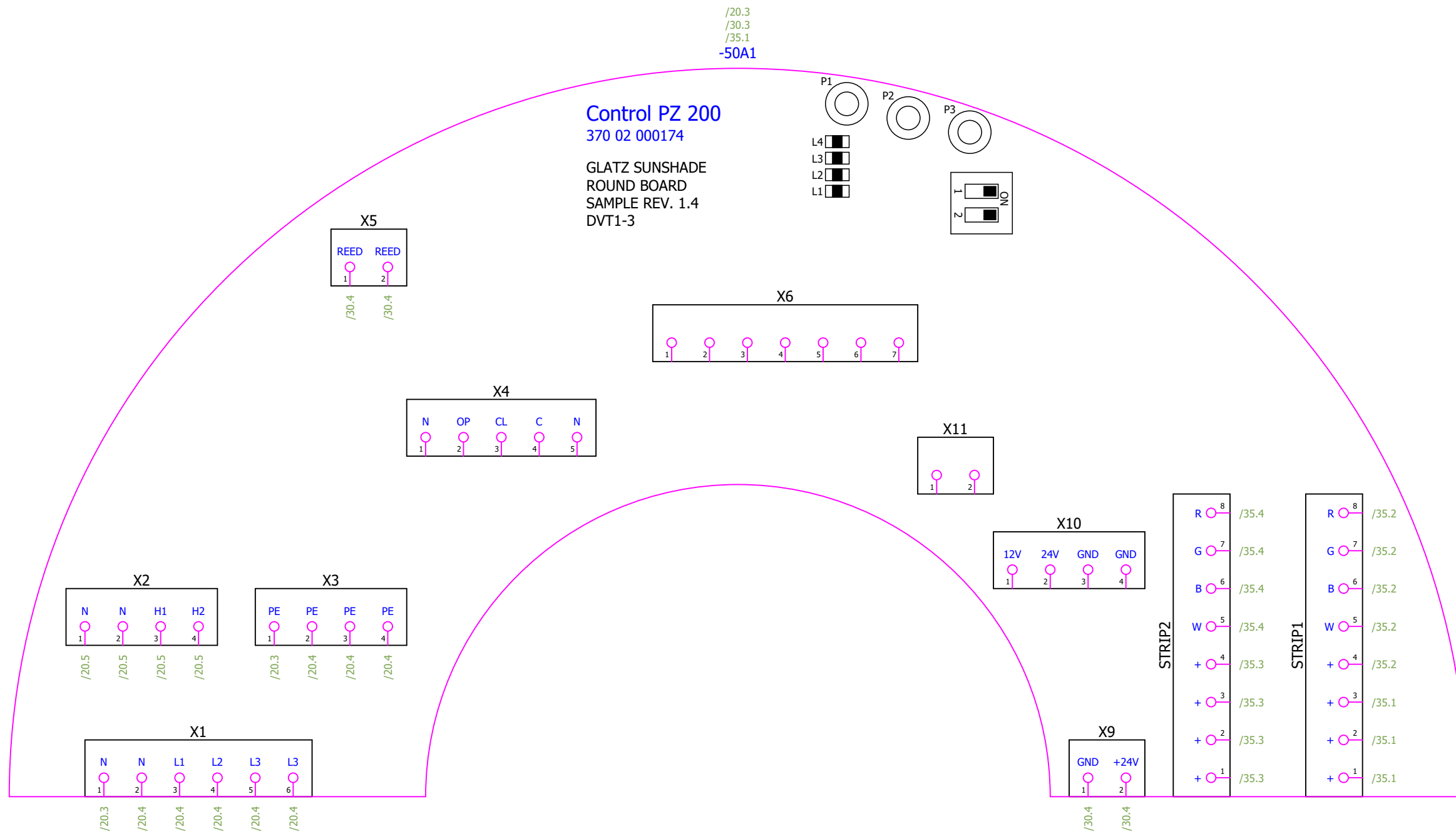

V1.0	19.02.2021	sstern	Date	19.02.2021	Sunshade control	Control PZ 200	= ANL
			Ed.	sstern	350 01 5620XX		+ ALLG
Modification	Date	Name			Replacement of	Replaced by	Drawing number
							350 01 5620XX
							Page
							50
							Page
							8 / 8



Glatz AG

Neuhofstrasse 12

CH-8500 Frauenfeld

Tél. 0041 52 723 64 64

Fax 0041 52 723 66 39

www.glatz.ch

Description de projet

Commande de parasol 350 01 5620XX

Modèle	LED
Année de fabrication	2021
Type de protection	-
Fusible auxiliaire	13A
Fréquence	50Hz
Conduite d'arrivée	L N PE
Tension de régulation	230V AC
Icp résistant aux courts-circuits	10kA
Température ambiante	20°C max. lors du fonctionnement du chauffage, sinon: jusqu'à 40°C max.

Edité le 19.02.2021

Nombre de pages 8

V1.0	19.02.2021	sstern	Date	19.02.2021	Commande de parasol	Page de garde	= ANL		Feuille	1
			Traitement	sstern	350 01 5620XX		+		Page	1 / 8
Modification	Date	Nom			Remplacement de	Remplacé par		Numéro de plan 350 01 5620XX		

Aperçu des identificateurs de structure

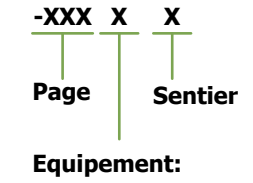
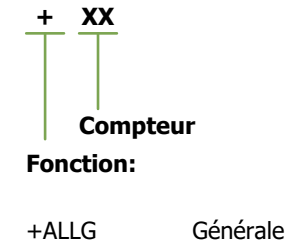
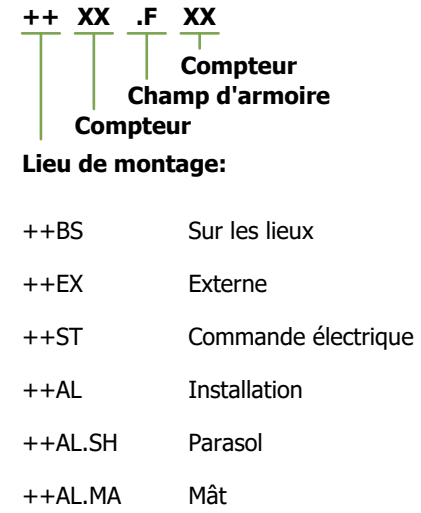
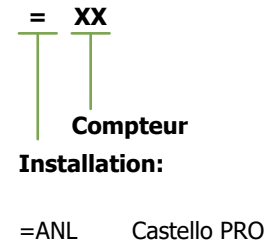
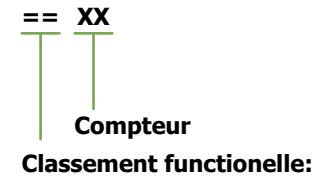

V1.0	19.02.2021	sstern	Date	19.02.2021	Commande de parasol	Aperçu des identificateurs de structure		= ANL
			Traitement	sstern	350 01 5620XX			+
Modification	Date	Nom			Remplacement de	Remplacé par		
							Numéro de plan	Feuille
							350 01 5620XX	10
								Page 3 / 8

++ST
Comande
électrique

-30T1
/30.1
BN
BU
GNYE
L3 / 30.1
N3 / 30.1
PE3 / 30.1

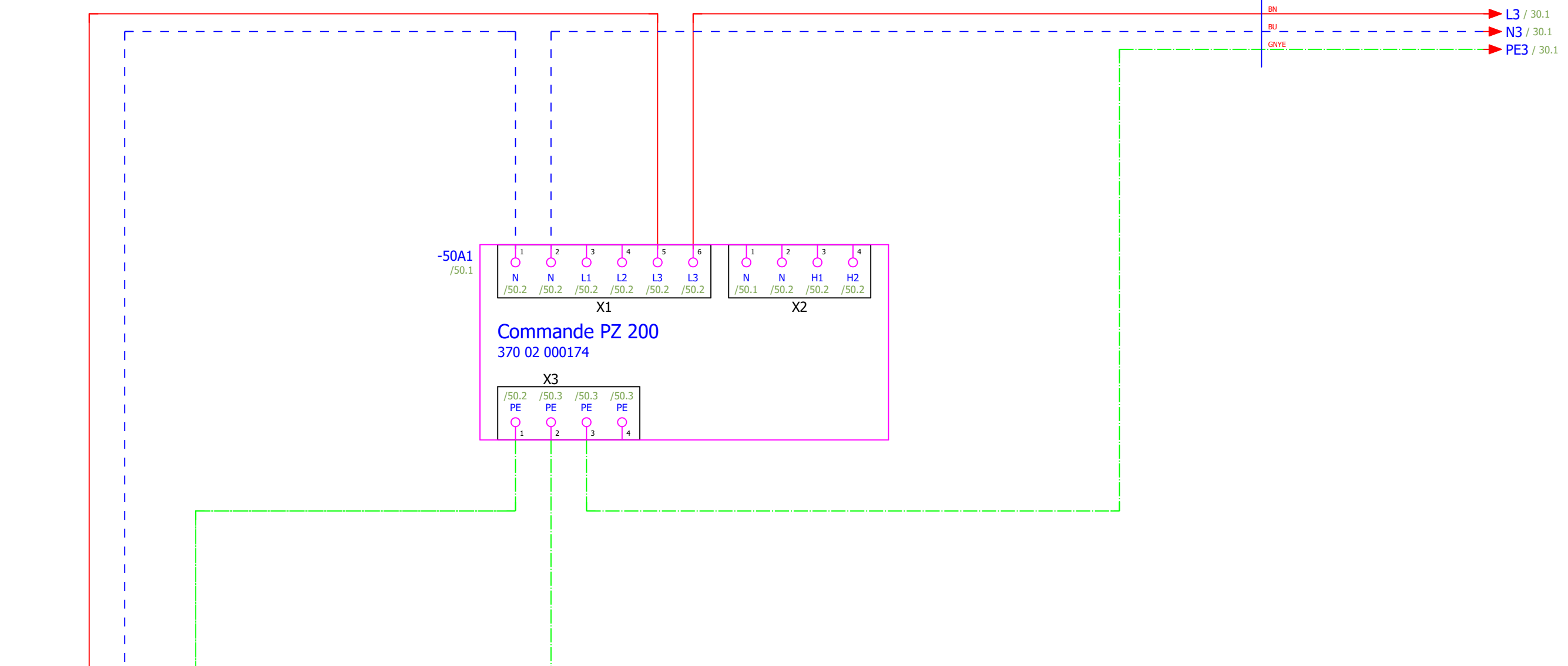

++EX
Externe

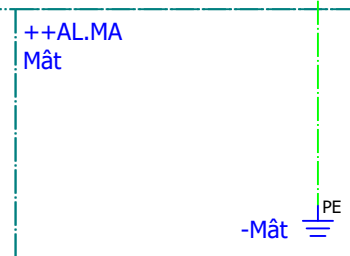
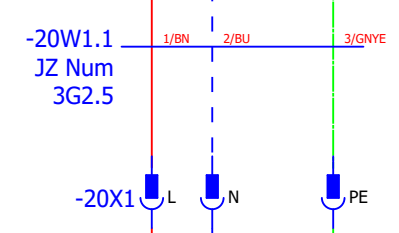

++BS
Sur les lieux

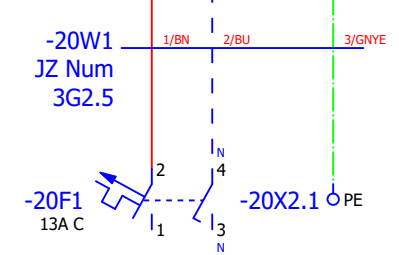

Alimentation	
Tension nominale	230V AC
Fusible d'entrée max.	13A
Réseau électrique	TN-S
Genre de conductibilité	L N PE
Fréquence	50Hz

V1.0	19.02.2021	sstern	Date	19.02.2021	Comande de parasol	Alimentation	= ANL	
			Traitement	sstern	350 01 5620XX		+ ALLG	
Modification	Date	Nom			Remplacement de	Remplacé par		
Numéro de plan							Feuille	20
350 01 5620XX							Page	4 / 8

++ST
Commande
électrique

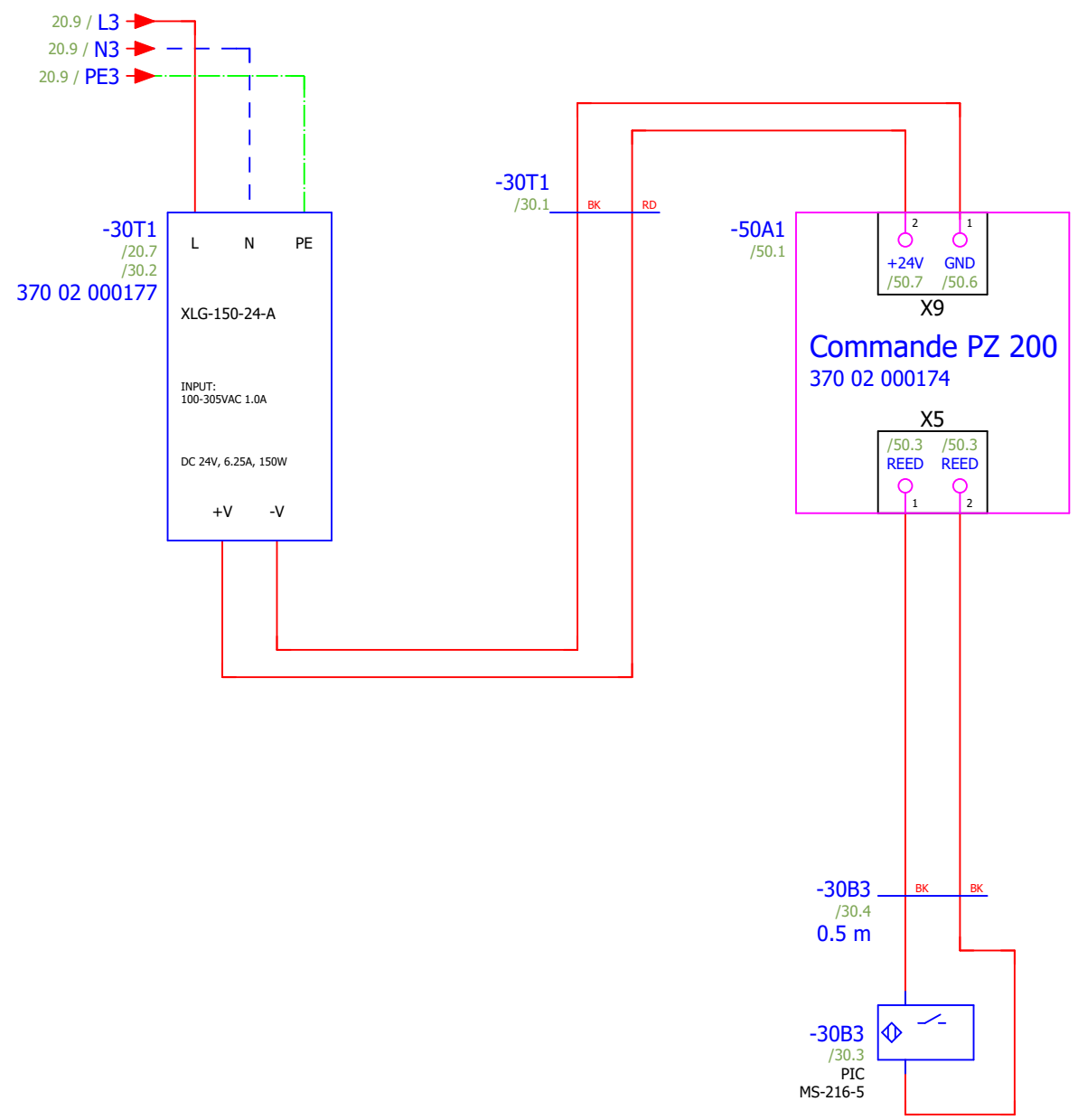

V1.0	19.02.2021	sstern	Date	19.02.2021	Commande de parasol 350 01 5620XX	Bloc d'alimentation/ Commutateurs à lames	= ANL	
			Traitement	sstern			+ ALLG	
Modification	Date	Nom			Remplacement de	Remplacé par		
							Numéro de plan	Feuille
							350 01 5620XX	30
								Page 5 / 8

-50A1
/50.1

Comande PZ 200
370 02 000174



36.1 / STRIP1_+
36.1 / STRIP1_W
36.1 / STRIP1_B
36.1 / STRIP1_G
36.1 / STRIP1_R

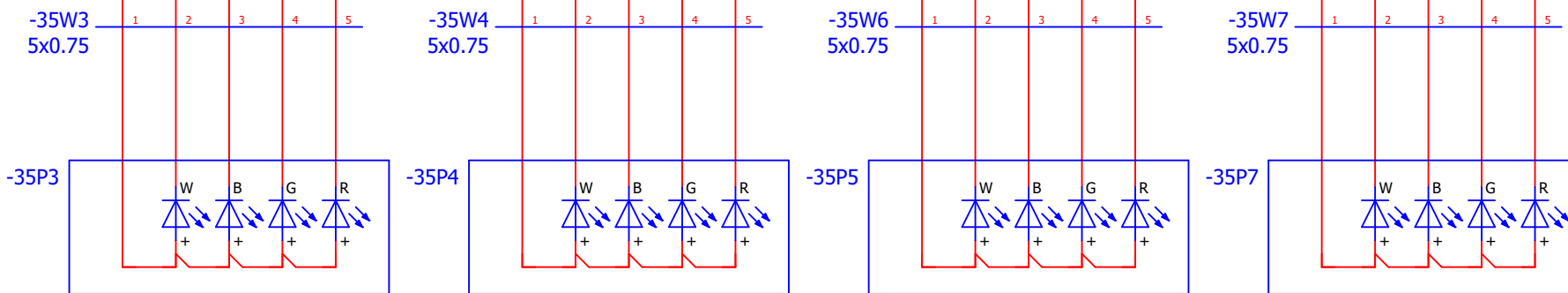
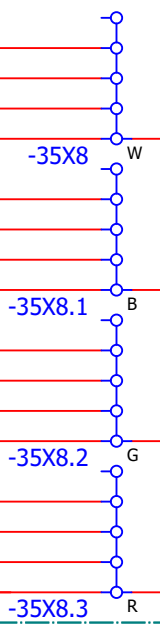

V1.0	19.02.2021	sstern	Date	19.02.2021	Comande de parasol	350 01 5620XX	Comande de lumière	= ANL	
			Traitement	sstern				+ ALLG	
Modification	Date	Nom			Remplacement de	Remplacé par			
Numéro de plan 350 01 5620XX								Feuille	35
								Page	6 / 8

++ST
Commande
électrique

35.2 / STRIP1_R
35.2 / STRIP1_G
35.2 / STRIP1_B
35.2 / STRIP1_W
35.2 / STRIP1_+

-36W1.1
5x0.75

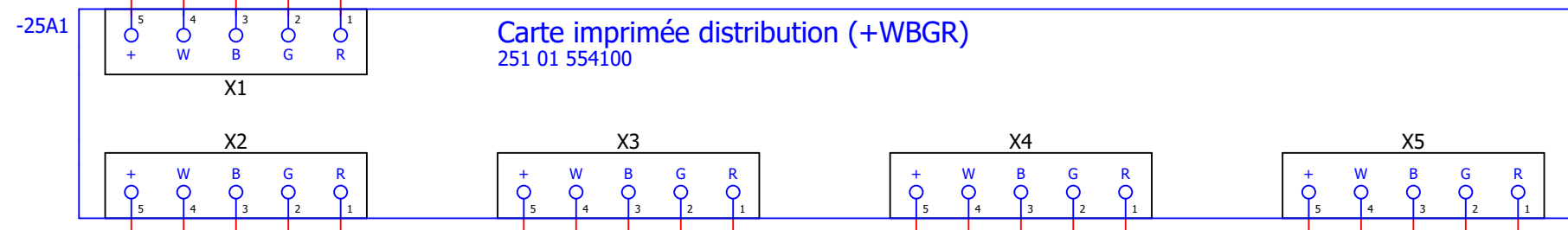

++AL.SH
Parasol

-36W1
5x0.75

-36W2
5x0.75

-36W4
5x0.75

-36W5
5x0.75

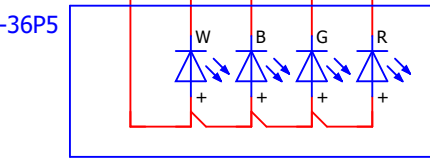
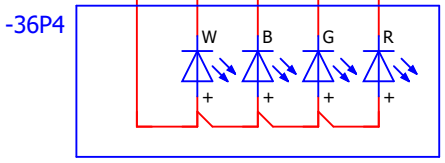
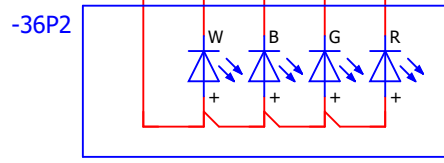
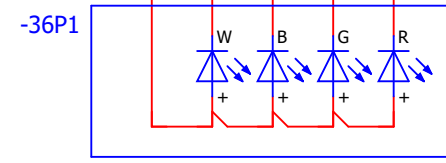

LED 5

LED 6

LED 7

LED 8

V1.0	19.02.2021	sstern	Date	19.02.2021	Commande de parasol	Commande de lumière	= ANL
			Traitement	sstern	350 01 5620XX		+ ALLG
Modification	Date	Nom			Remplacement de	Remplacé par	
Numéro de plan 350 01 5620XX							Feuille 36 Page 7 / 8

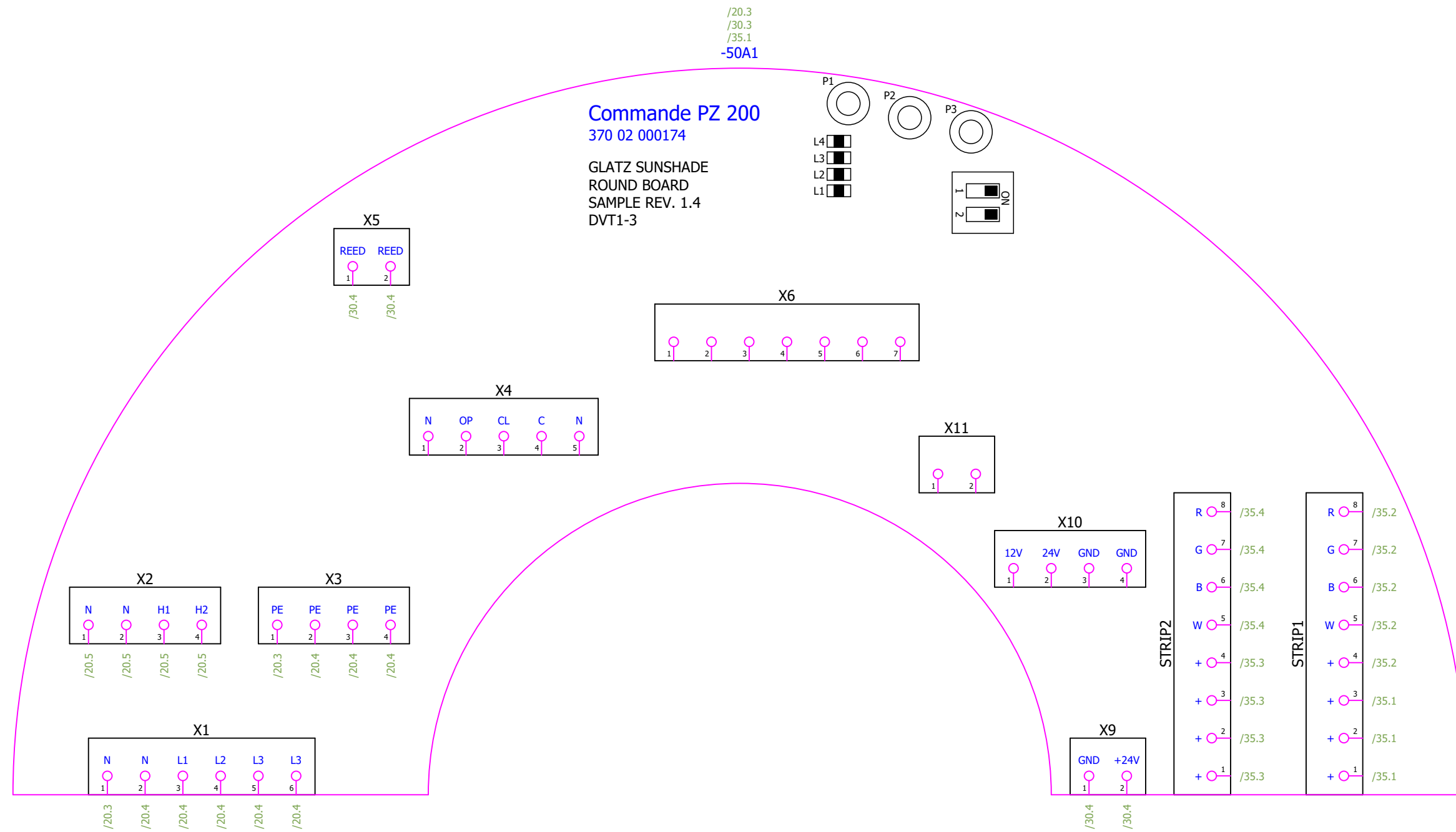

V1.0	19.02.2021	sstern	Date	19.02.2021	Comande de parasol	Comande PZ 200	= ANL
			Traitement	sstern	350 01 5620XX		+ ALLG
Modification	Date	Nom			Remplacement de	Remplacé par	
Numéro de plan 350 01 5620XX							Feuille 50 Page 8 / 8